

# TECHNICKÝ LIST

## pro UKL 3119L s USM

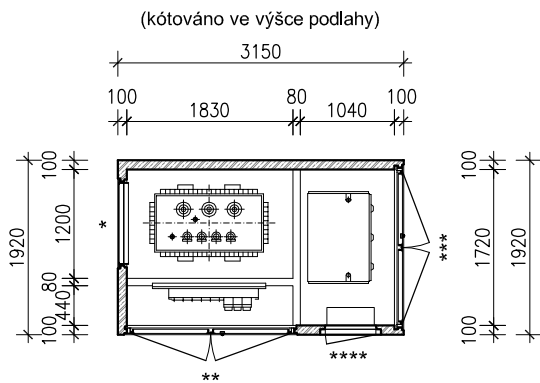

\*\*\*\* 1.varianta  
dveře  
TAM2 44/65 RS  
Fo = /

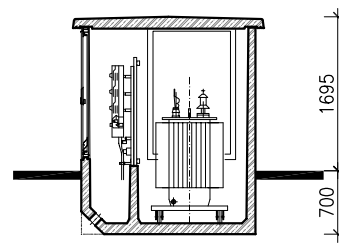
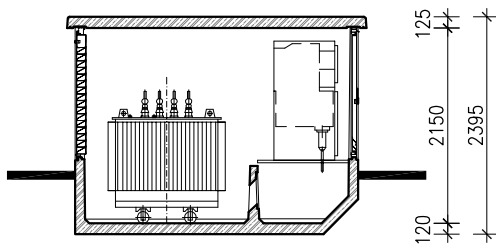
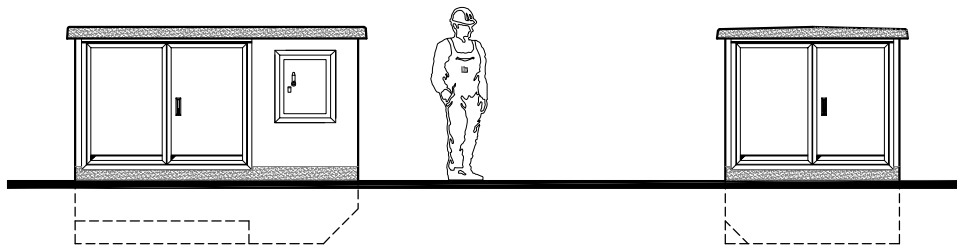

\*\* 1.varianta  
dveře  
TAM2 174/131 UT, RS  
Fo = 0.04 m<sup>2</sup>

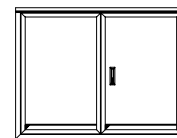

\*\*\*\* 2.varianta  
dveře  
TAM2 56/69 RS  
Fo = /



\*\*\* 1.varianta  
dveře  
TAM2 165.6/131 UT, RS  
Fo = 0.04 m<sup>2</sup>

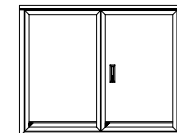

\* 1.varianta  
pevný větrací element  
LLSF 93/142.9  
Fo = 0.58 m<sup>2</sup>

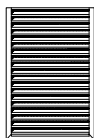

\* 2.varianta  
odnímatelný větrací element  
LLS 93/136.9  
Fo = 0.52 m<sup>2</sup>

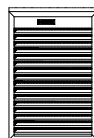

\* 3.varianta  
větrací dveře  
TAML 82.2/131 RS/LS  
Fo = 0.39 m<sup>2</sup>

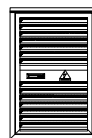

\* 4.varianta  
zabetonováno  
Fo = /

